

# 6RP 15 SERIES PUMP DESIGN

## Material Specification

No	PART NAME	MATERIAL
1	DISCHARGE CHAMBER HOUSING	STEEL CAST 304
2	VALVE	S.S.304
3	VALVE SEAT	N.B.R. + S.S.304
4	SPACING WASHER	25% CFT
5	INTERMEDIATE CHAMBER TOP	S.S.304
6	BEARING BUSH	N.B.R.
7	NECKRING	N.B.R. + NYLON
8	INTERMEDIATE CHAMBER	S.S.304
9	COLLET & COLLET NUT	S.S.304
10	IMPELLER	S.S.304
11	INTERMEDIATE CHAMBER 1St	S.S.304
12	PUMP SHAFT (UP TO 26 STAGES)	S.S.431
	PUMP SHAFT (27 STAGE & ABOVE)	S.S.1.4362
13	CLAMPING STRIP	S.S.304
14	SUCTION CONNECTOR	S.S.304
15	STRAINER	S.S.304
16	PRIMING SCREW	S.S.304
17	NEMA COUPLING	S.S.304
18	CABLE GUARD	S.S.304
19	HEX NUT	S.S.316
20	SUCTION	STEEL CAST 304

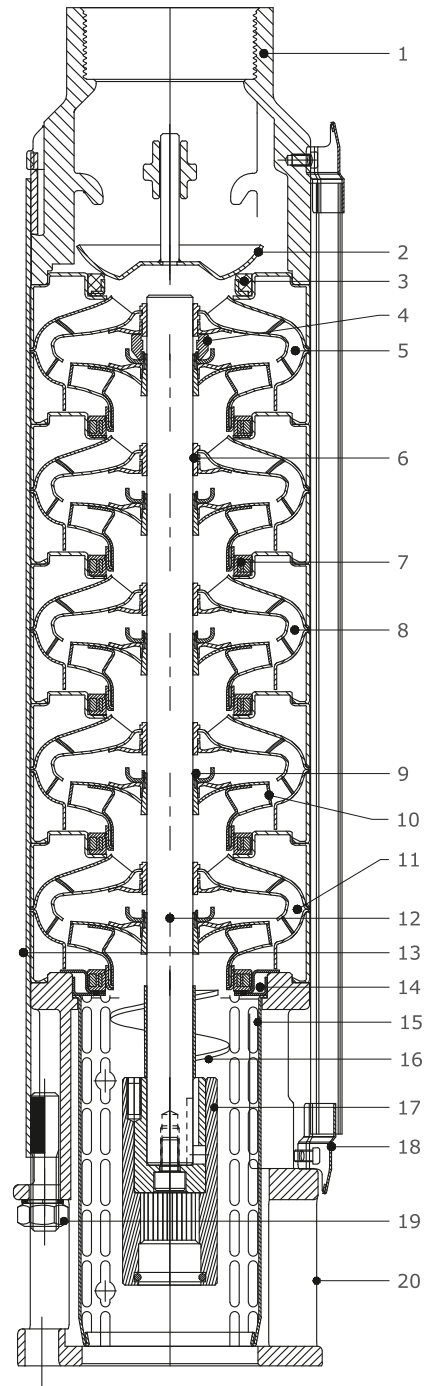

Note:  
 PUMPS UP TO 20 STAGE DISCHARGE CHAMBER COMES WITH S.S. FABRICATED AND FROM 21 STAGE & ONWARDS WITH STEEL CAST.

6RP 15, 60Hz  
ISO 9906 Annexure A

# PERFORMANCE CURVES

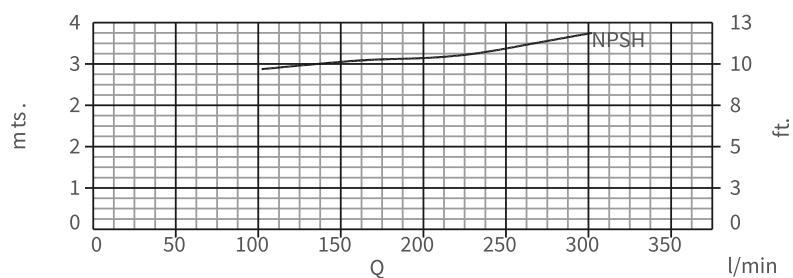
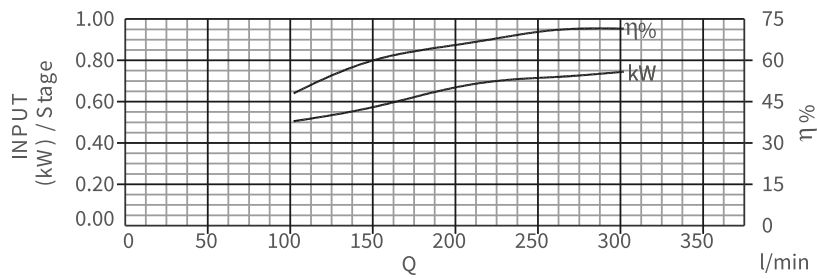
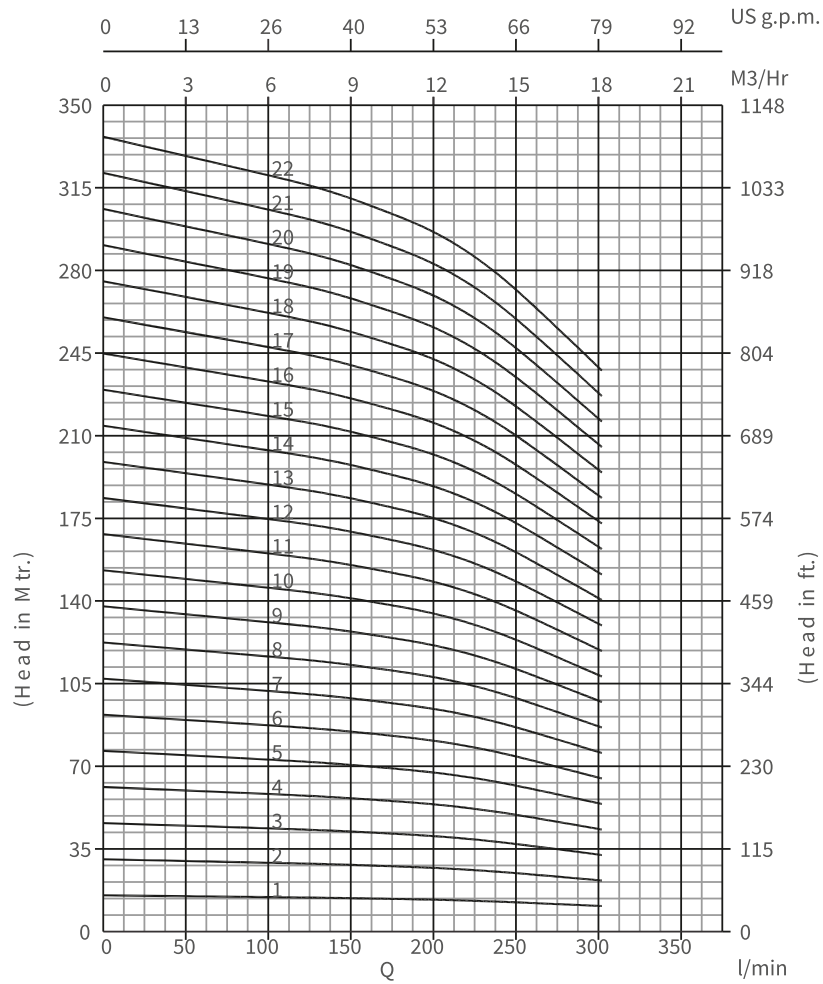

# PERFORMANCE CURVES

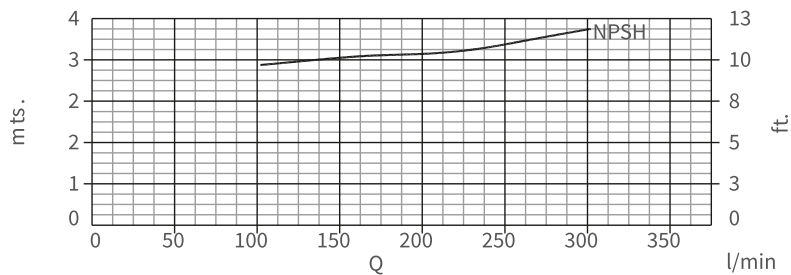
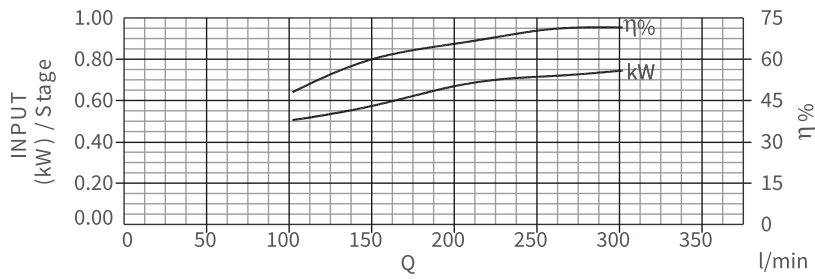
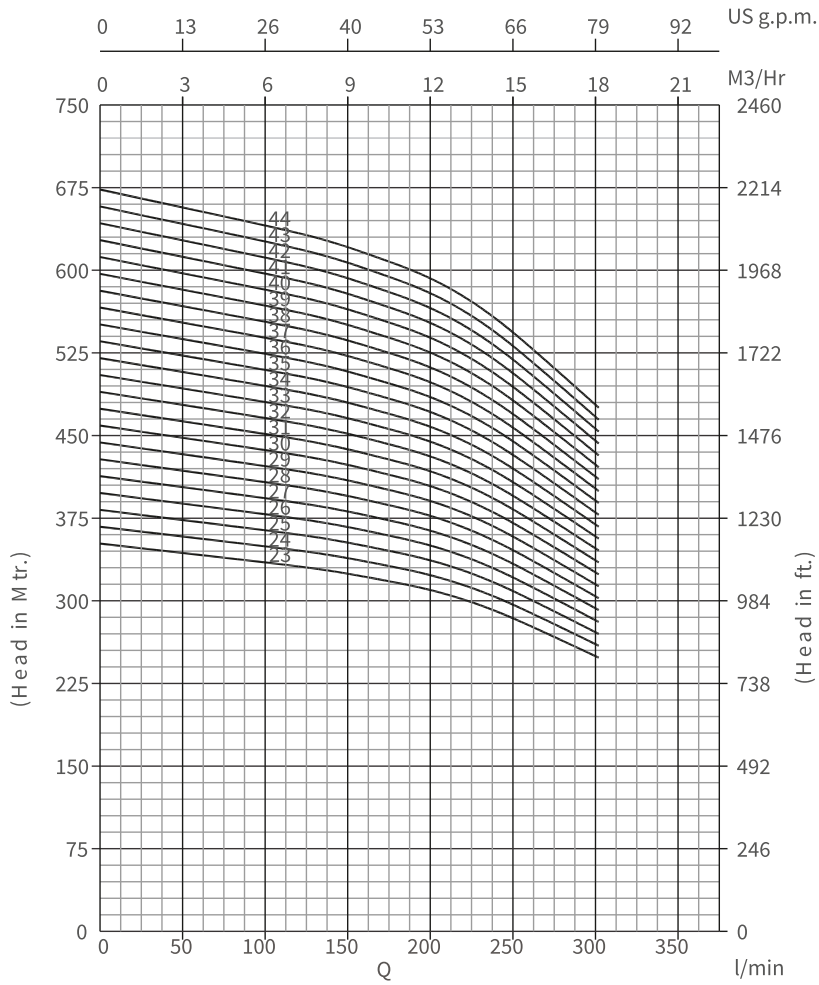

**6RP 15, 60Hz**  
ISO 9906 Annexure A

# PERFORMANCE CHART

MODEL NAME		RATING			DISCHARGE							
THREE PHASE	STAGE	kW	HP	l/min	0	102	135	168	201	235	266	302
				m <sup>3</sup> /h	0	6.1	8.1	10.0	12.0	14.1	15.9	18.1

MODEL NAME	STAGE	RATING kW	RATING HP	DISCHARGE l/min	DISCHARGE m <sup>3</sup> /h	DISCHARGE l/min	DISCHARGE m <sup>3</sup> /h	DISCHARGE l/min	DISCHARGE m <sup>3</sup> /h	DISCHARGE l/min	DISCHARGE m <sup>3</sup> /h	DISCHARGE l/min	DISCHARGE m <sup>3</sup> /h
6RP 15-01	1	0.75	1.00	15.3	14.5	14.3	14	13.5	13	12	11		
6RP 15-02	2	1.50	2.00	31	29	29	28	27	26	24	22		
6RP 15-03	3	2.20	3.00	46	44	43	42	40	38	36	32		
6RP 15-04	4	3.00	4.00	61	58	57	56	54	51	48	43		
6RP 15-05	5	4.00	5.50	76	73	72	70	68	64	60	54		
6RP 15-06	6	5.50	7.50	92	87	86	83	81	77	71	65		
6RP 15-07	7	5.50	7.50	107	102	100	97	94	90	83	76		
6RP 15-08	8	7.50	10.00	122	116	114	111	108	102	95	86		
6RP 15-09	9	7.50	10.00	138	131	129	125	122	115	107	97		
6RP 15-10	10	7.50	10.00	153	146	143	139	135	128	119	108		
6RP 15-11	11	9.30	12.50	168	160	157	153	148	141	131	119		
6RP 15-12	12	9.30	12.50	184	175	172	167	162	154	143	130		
6RP 15-13	13	9.30	12.50	199	189	186	181	176	166	155	140		
6RP 15-14	14	11.00	15.00	214	204	200	195	189	179	167	151		
6RP 15-15	15	11.00	15.00	230	218	214	208	202	192	178	162		
6RP 15-16	16	13.00	17.50	245	233	229	222	216	205	190	173		
6RP 15-17	17	13.00	17.50	260	247	243	236	230	218	202	184		
6RP 15-18	18	13.00	17.50	275	262	257	250	243	230	214	194		
6RP 15-19	19	15.00	20.00	291	276	272	264	256	243	226	205		
6RP 15-20	20	15.00	20.00	306	291	286	278	270	256	238	216		
6RP 15-21	21	15.00	20.00	321	306	300	292	284	269	250	227		
6RP 15-22	22	18.50	25.00	337	320	315	306	297	282	262	238		
6RP 15-23	23	18.50	25.00	352	335	329	320	310	294	274	248		
6RP 15-24	24	18.50	25.00	367	349	343	334	324	307	286	259		
6RP 15-25	25	18.50	25.00	382	364	358	348	338	320	298	270		
6RP 15-26	26	18.50	25.00	398	378	372	361	351	333	309	281		
6RP 15-27	27	22.00	30.00	413	393	386	375	364	346	321	292		
6RP 15-28	28	22.00	30.00	428	407	400	389	378	358	333	302		
6RP 15-29	29	22.00	30.00	444	422	415	403	392	371	345	313		
6RP 15-30	30	22.00	30.00	459	436	429	417	405	384	357	324		
6RP 15-31	31	22.00	30.00	474	451	443	431	418	397	369	335		
6RP 15-32	32	26.00	35.00	490	466	458	445	432	410	381	346		
6RP 15-33	33	26.00	35.00	505	480	472	459	446	422	393	356		
6RP 15-34	34	26.00	35.00	520	495	486	473	459	435	405	367		
6RP 15-35	35	26.00	35.00	536	509	500	486	472	448	416	378		
6RP 15-36	36	26.00	35.00	551	524	515	500	486	461	428	389		
6RP 15-37	37	26.00	35.00	566	538	529	514	500	474	440	400		
6RP 15-38	38	30.00	40.00	581	553	543	528	513	486	452	410		
6RP 15-39	39	30.00	40.00	597	567	558	542	526	499	464	421		
6RP 15-40	40	30.00	40.00	612	582	572	556	540	512	476	432		
6RP 15-41	41	30.00	40.00	627	597	586	570	554	525	488	443		
6RP 15-42	42	30.00	40.00	643	611	601	584	567	538	500	454		
6RP 15-43	43	37.00	50.00	658	626	615	598	580	550	512	464		
6RP 15-44	44	37.00	50.00	673	640	629	612	594	563	524	475		

HEAD IN Mtrs.

## Dimensions & Weights

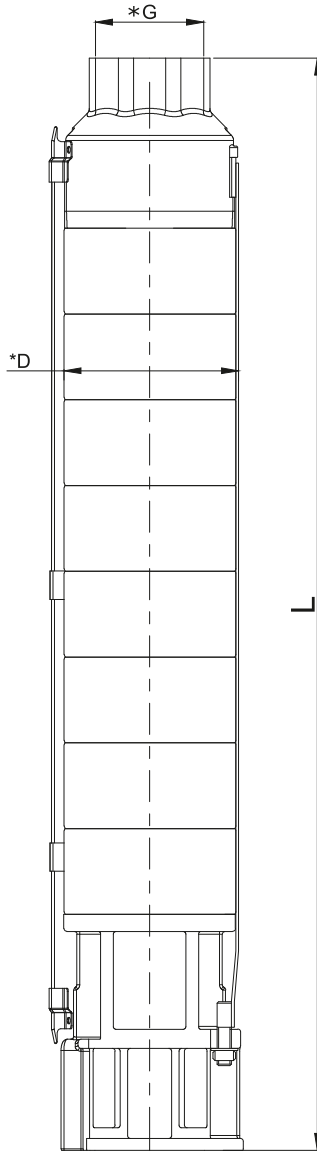

Model Name	Specification			
	*D (mm)	L (mm)	Pump Weight Kg.	Weight (Incl. pkg.) Kg.
6RP 15 - 01	142	331	8	10
6RP 15 - 02	142	392	9	11
6RP 15 - 03	142	452	10	12
6RP 15 - 04	142	513	12	14
6RP 15 - 05	142	573	13	15
6RP 15 - 06	142	634	14	16
6RP 15 - 07	142	694	15	17
6RP 15 - 08	142	755	17	19
6RP 15 - 09	142	815	18	20
6RP 15 - 10	142	894	19	21
6RP 15 - 11	142	955	20	23
6RP 15 - 12	142	1015	22	24
6RP 15 - 13	142	1076	23	25
6RP 15 - 14	142	1136	24	26
6RP 15 - 15	142	1197	25	28
6RP 15 - 16	142	1257	26	29
6RP 15 - 17	142	1318	28	31
6RP 15 - 18	142	1378	29	32
6RP 15 - 19	142	1439	30	33
6RP 15 - 20	142	1499	31	34
6RP 15 - 21	142	1560	33	36
6RP 15 - 22	142	1620	34	37
6RP 15 - 23	142	1681	35	39
6RP 15 - 24	142	1741	36	40
6RP 15 - 25	142	1802	38	41
6RP 15 - 26	142	1862	39	42
6RP 15 - 27	142	1923	40	43
6RP 15 - 28	142	1983	41	45
6RP 15 - 29	142	2044	42	46
6RP 15 - 30	142	2104	44	47
6RP 15 - 31	142	2165	45	49
6RP 15 - 32	142	2225	46	50
6RP 15 - 33	142	2286	47	51
6RP 15 - 34	142	2346	49	53
6RP 15 - 35	142	2407	50	54
6RP 15 - 36	142	2467	51	55
6RP 15 - 37	142	2528	52	56
6RP 15 - 38	142	2588	53	57
6RP 15 - 39	142	2649	55	59
6RP 15 - 40	142	2709	56	60
6RP 15 - 41	142	2770	57	62
6RP 15 - 42	142	2830	58	63
6RP 15 - 43	142	2891	60	64
6RP 15 - 44	142	2951	61	65

\*G : Available Outlet Size 2.5" NPT & 3.0" NPT

\*D : With Cable Guard

6RP 15 - 01 to 6RP 15-10 Pumps Are Also Available In 4" Joining.

# 6RP 18 SERIES PUMP DESIGN

## Material Specification

No	PART NAME	MATERIAL
1	DISCHARGE CHAMBER HOUSING	STEEL CAST 304
2	VALVE	S.S.304
3	VALVE SEAT	N.B.R. + S.S.304
4	SPACING WASHER	25% CFT
5	INTERMEDIATE CHAMBER TOP	S.S.304
6	BEARING BUSH	N.B.R.
7	NECKRING	N.B.R. + NYLON
8	INTERMEDIATE CHAMBER	S.S.304
9	COLLET & COLLET NUT	S.S.304
10	IMPELLER	S.S.304
11	INTERMEDIATE CHAMBER 1st	S.S.304
12	PUMP SHAFT (UP TO 26 STAGES)	S.S.431
	PUMP SHAFT (27 STAGE & ABOVE)	S.S.1.4362
13	CLAMPING STRIP	S.S.304
14	SUCTION CONNECTOR	S.S.304
15	STRAINER	S.S.304
16	PRIMING SCREW	S.S.304
17	NEMA COUPLING	S.S.304
18	CABLE GUARD	S.S.304
19	HEX NUT	S.S.316
20	SUCTION	STEEL CAST 304

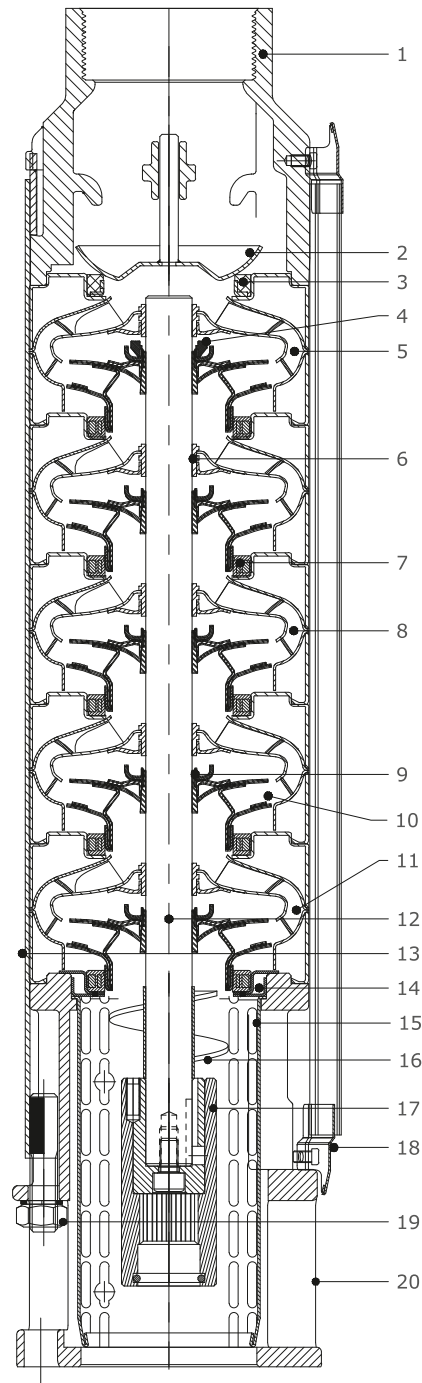

Note:  
PUMPS UP TO 20 STAGE DISCHARGE CHAMBER COMES WITH S.S. FABRICATED AND FROM 21 STAGE & ONWARDS WITH STEEL CAST.

# PERFORMANCE CURVES

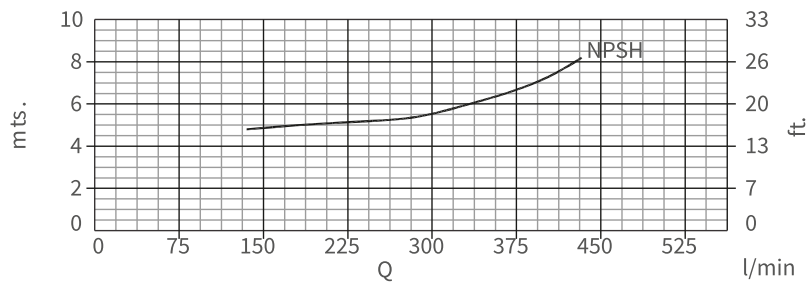
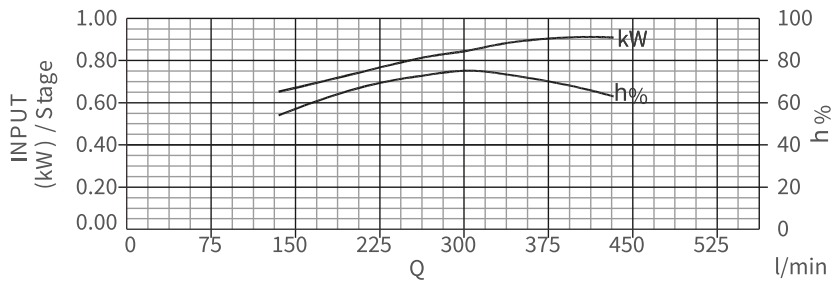
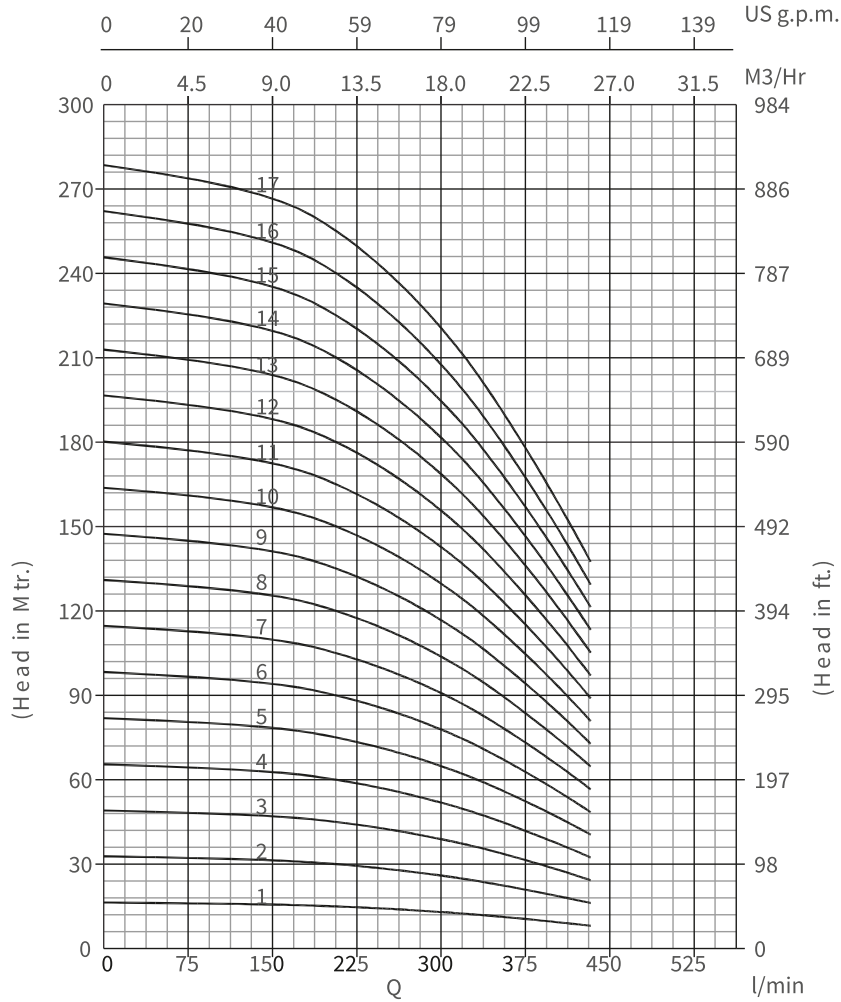

**6RP 18, 60Hz**  
ISO 9906 Annexure A

## PERFORMANCE CHART

MODEL NAME	STAGE	RATING		DISCHARGE								
		kW	HP		l/min	0	135	200	267	300	333	400
THREE PHASE				m <sup>3</sup> /h	0	8.1	12	16	18	20	24	26

MODEL NAME	STAGE	kW	HP	DISCHARGE	0	135	200	267	300	333	400	433
6RP 18-01	1	1.10	1.50	16.4	16	15	14	13	12	10	8	
6RP 18-02	2	2.20	3.00	33	32	30	28	26	24	19	16	
6RP 18-03	3	3.00	4.00	49	48	46	42	39	36	29	24	
6RP 18-04	4	4.00	5.50	66	64	61	55	52	48	38	32	
6RP 18-05	5	5.50	7.50	82	80	76	69	65	60	48	40	
6RP 18-06	6	5.50	7.50	98	96	91	83	78	72	57	49	
6RP 18-07	7	7.50	10.00	115	112	107	97	91	84	67	57	
6RP 18-08	8	7.50	10.00	131	128	122	111	104	96	76	65	
6RP 18-09	9	7.50	10.00	147	144	137	125	117	108	86	73	
6RP 18-10	10	9.30	12.50	164	160	152	139	130	120	96	81	
6RP 18-11	11	9.30	12.50	180	175	168	152	143	133	105	89	
6RP 18-12	12	11.00	15.00	197	191	183	166	156	145	115	97	
6RP 18-13	13	11.00	15.00	213	207	198	180	169	157	124	105	
6RP 18-14	14	13.00	17.50	229	223	213	194	182	169	134	113	
6RP 18-15	15	13.00	17.50	246	239	229	208	195	181	143	121	
6RP 18-16	16	15.00	20.00	262	255	244	222	208	193	153	129	
6RP 18-17	17	15.00	20.00	278	271	259	236	221	205	162	138	

# PERFORMANCE CURVES

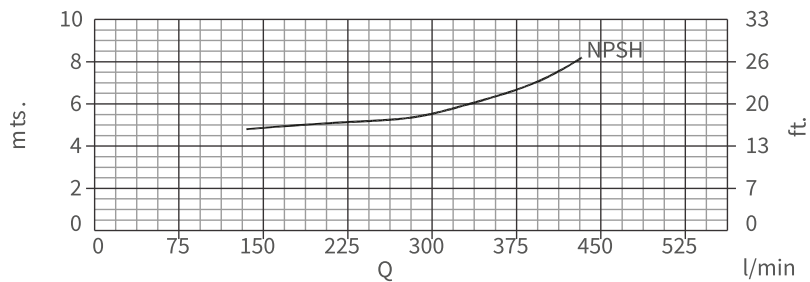
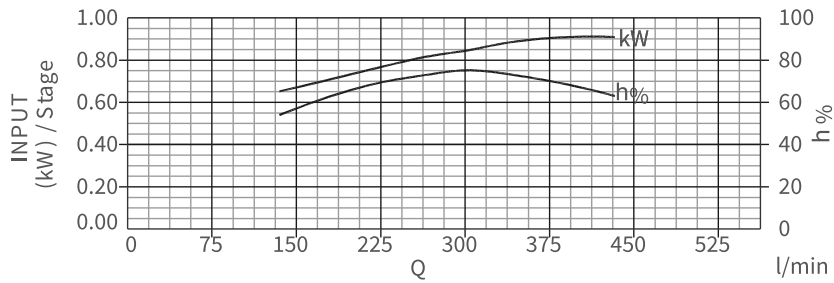
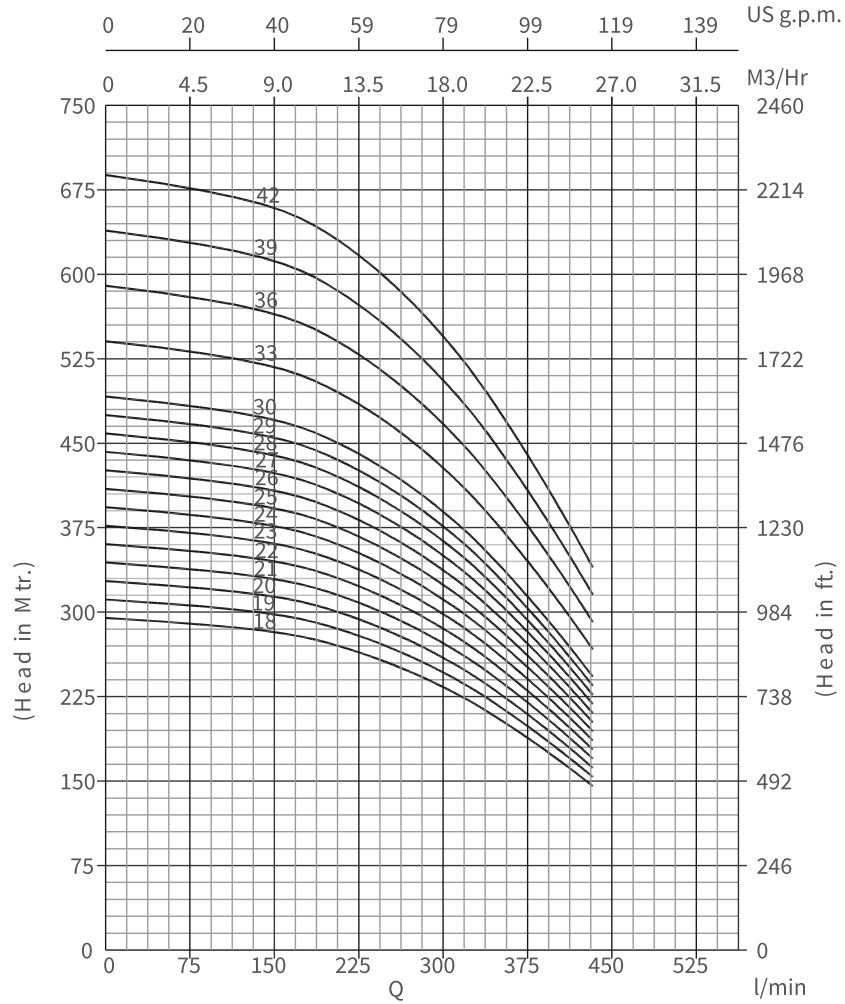

**6RP 18, 60Hz**  
ISO 9906 Annexure A

## PERFORMANCE CHART

MODEL NAME	STAGE	RATING		l/min	DISCHARGE							
		kW	HP		0	135	200	267	300	333	400	433
THREE PHASE				m <sup>3</sup> /h	0	8.1	12	16	18	20	24	26

MODEL NAME	STAGE	kW	HP	HEAD IN M trs .	295	287	274	249	234	217	172	146
6RP 18-18	18	15.00	20.00		295	287	274	249	234	217	172	146
6RP 18-19	19	18.50	25.00		311	303	290	263	247	229	181	154
6RP 18-20	20	18.50	25.00		328	319	305	277	260	241	191	162
6RP 18-21	21	18.50	25.00		344	335	320	291	273	253	201	170
6RP 18-22	22	18.50	25.00		360	351	335	305	286	265	210	178
6RP 18-23	23	22.00	30.00		377	367	351	319	299	277	220	186
6RP 18-24	24	22.00	30.00		393	383	366	333	312	289	229	194
6RP 18-25	25	22.00	30.00		409	399	381	346	324	301	239	202
6RP 18-26	26	22.00	30.00		426	415	396	360	337	313	248	210
6RP 18-27	27	26.00	35.00		442	431	411	374	350	325	258	218
6RP 18-28	28	26.00	35.00		459	447	427	388	363	337	267	227
6RP 18-29	29	26.00	35.00		475	463	442	402	376	349	277	235
6RP 18-30	30	26.00	35.00		491	478	457	416	389	362	286	243
6RP 18-33	33	30.00	40.00		541	526	503	457	428	398	315	267
6RP 18-36	36	30.00	40.00		590	574	549	499	467	434	344	291
6RP 18-39	39	37.00	50.00		639	622	594	541	506	470	372	316
6RP 18-42	42	37.00	50.00		688	670	640	582	545	506	401	340

# 6RP 18, 60Hz

ISO 9906 Annexure A

## Dimensions & Weights

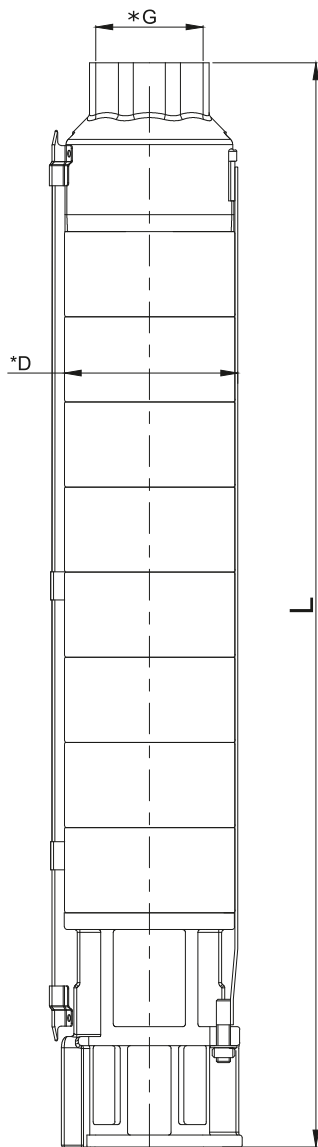

Model Name	Specification			
	*D (mm)	L (mm)	Pump Weight Kg.	Weight (Incl. pkg.) Kg.
6RP 18 - 01	142	331	8	10
6RP 18 - 02	142	392	9	11
6RP 18 - 03	142	452	11	13
6RP 18 - 04	142	513	12	14
6RP 18 - 05	142	573	13	15
6RP 18 - 06	142	634	14	16
6RP 18 - 07	142	694	16	18
6RP 18 - 08	142	755	17	19
6RP 18 - 09	142	815	18	20
6RP 18 - 10	142	894	19	21
6RP 18 - 11	142	955	21	23
6RP 18 - 12	142	1015	22	24
6RP 18 - 13	142	1076	23	26
6RP 18 - 14	142	1136	24	27
6RP 18 - 15	142	1197	26	28
6RP 18 - 16	142	1257	27	30
6RP 18 - 17	142	1318	28	31
6RP 18 - 18	142	1378	29	32
6RP 18 - 19	142	1439	31	34
6RP 18 - 20	142	1499	32	35
6RP 18 - 21	142	1560	33	37
6RP 18 - 22	142	1620	34	38
6VP 18 - 23	142	1681	36	39
6RP 18 - 24	142	1741	37	40
6RP 18 - 25	142	1802	38	42
6RP 18 - 26	142	1862	39	43
6RP 18 - 27	142	1923	41	44
6RP 18 - 28	142	1983	42	45
6RP 18 - 29	142	2044	43	47
6RP 18 - 30	142	2104	44	48
6RP-18 - 33	142	2286	48	52
6RP-18 - 36	142	2467	52	56
6RP-18 - 39	142	2649	56	60
6RP-18 - 42	142	2830	60	64

\*G : Available Outlet Size 2.5" NPT & 3.0" NPT  
 \*D : With Cable Guard

6RP 18-01 to 6RP 18-09 pumps are also available in 4" joining.

# 6RP 32 SERIES PUMP DESIGN

## Material Specification

No	PART NAME	MATERIAL
1	DISCHARGE CHAMBER HOUSING	STEEL CAST 304
2	VALVE	S.S.304
3	VALVE SEAT	N.B.R. + S.S.304
4	TOP & FIRST BEARING BUSH	N.B.R. + S.S.304
5	INTERMEDIATE CHAMBER TOP	S.S.304
6	NECKRING	N.B.R. + NYLON
7	BEARING BUSH	N.B.R.
8	INTER MEDIATE CHAMBER	S.S.304
9	COLLET NUT	S.S.304
10	IMPELLER	S.S.304
11	COLLET	S.S.304
12	PUMP SHAFT (UP TO 18 STAGES)	S.S.431
	PUMP SHAFT (19 STAGE & ABOVE)	S.S.1.4362
13	INTER MEDIATE CHAMBER 1st	S.S.304
14	SPACING WASHER	25% CFT
15	CONNECTOR	S.S.304
16	STRAINER	S.S.304
17	CLAMPING STRIP	S.S.304
18	CABLE GUARD	S.S.304
19	NEMA COUPLING	S.S.304
20	HEX NUT	S.S.316
21	SUCTION	STEEL CAST 304

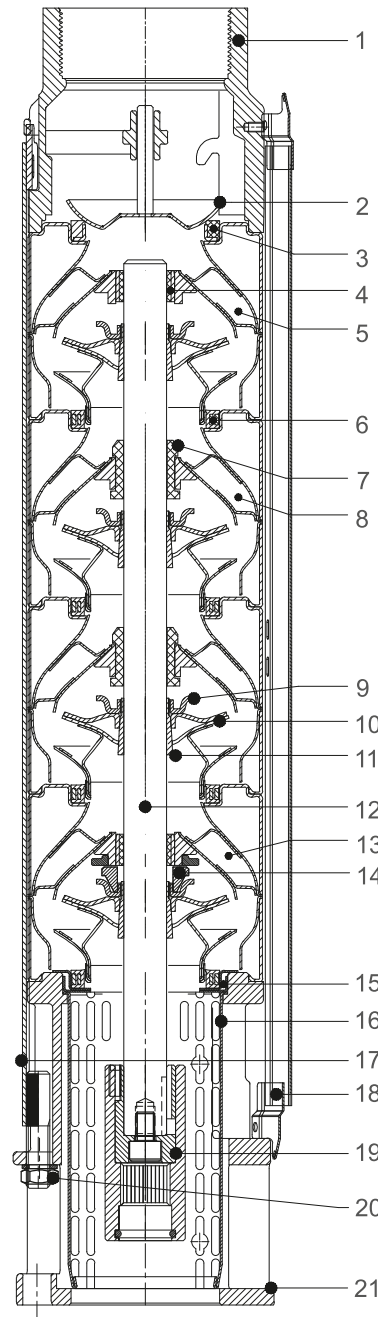

**Note:**

PUMPS UP TO 20 STAGE DISCHARGE CHAMBER COMES WITH S.S. FABRICATED AND FROM 21 STAGE & ONWARDS WITH STEEL CAST.

# PERFORMANCE CURVES

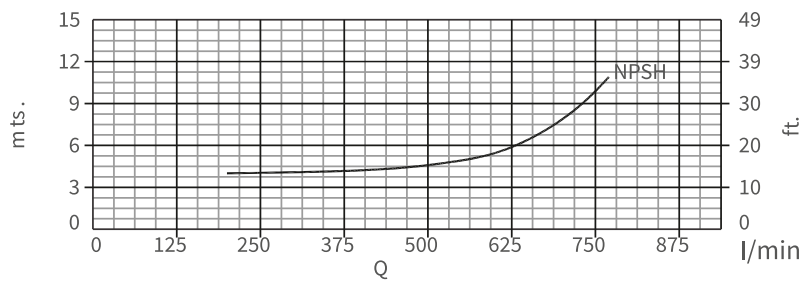
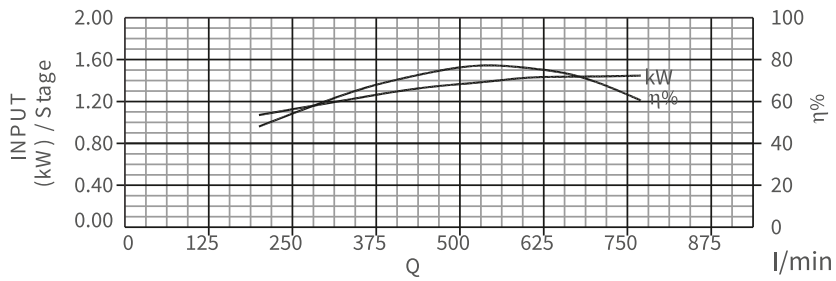
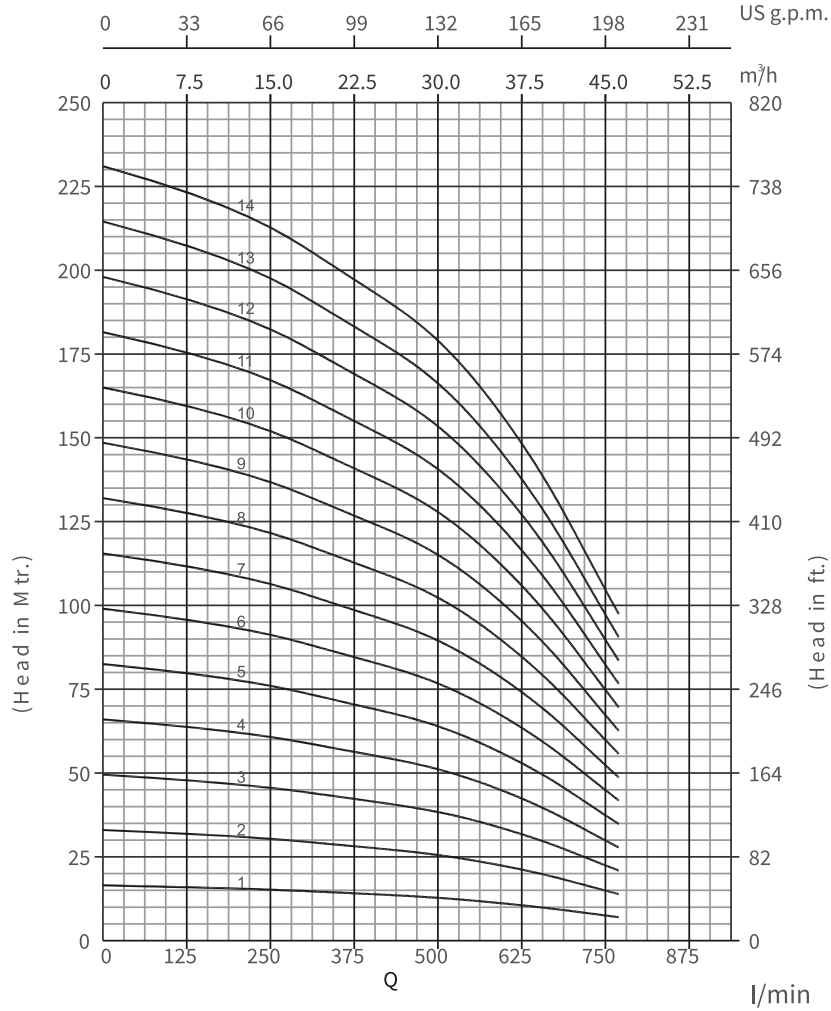

6RP 32, 60Hz  
ISO 9906 Annexure A

# PERFORMANCE CURVES

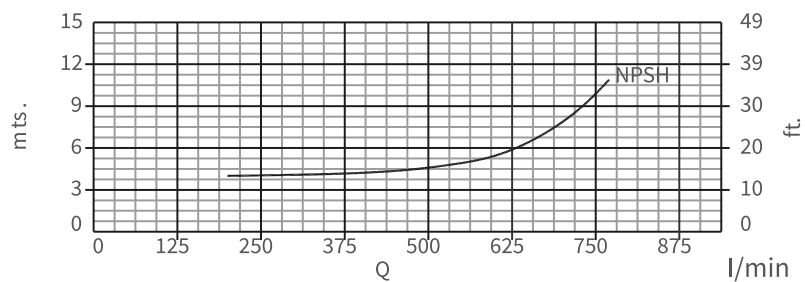
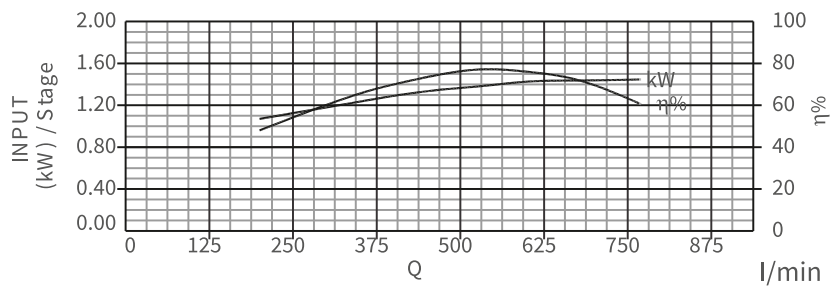
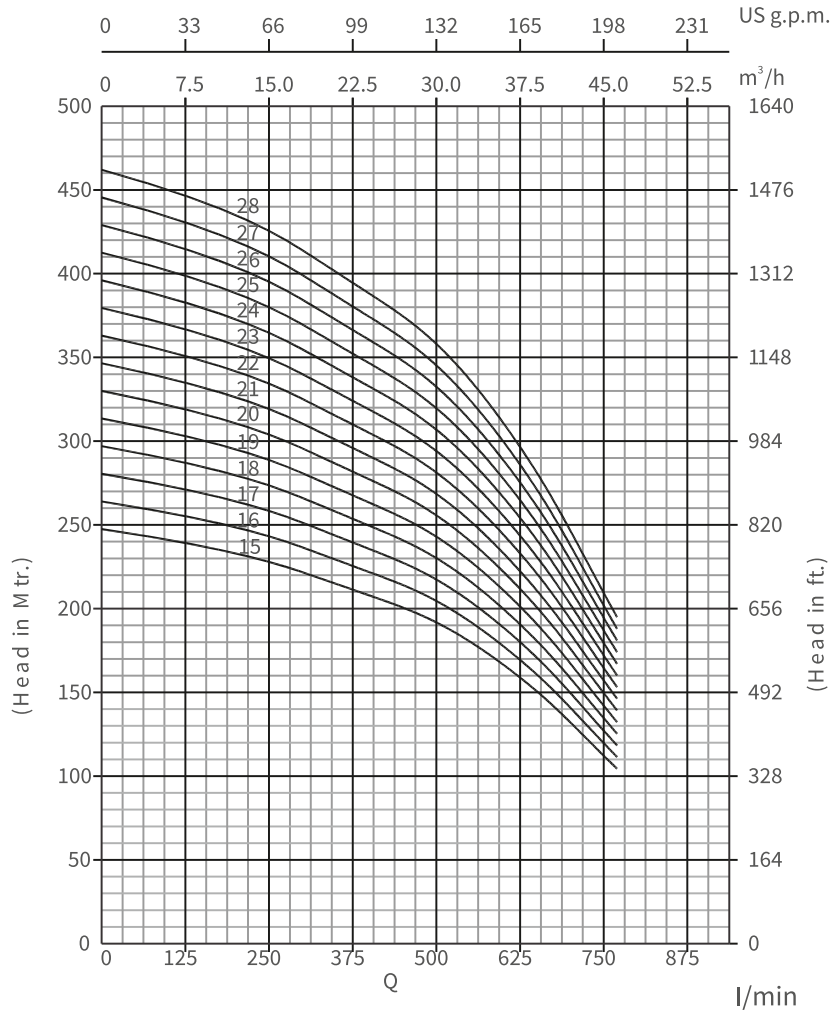

# PERFORMANCE CHART

Model Name		Rating			Discharge									
Three Phase	Stage	kW	HP	l/min	0	200	335	400	470	535	600	670	735	770
				m <sup>3</sup> /h	0	12.0	20.1	24.0	28.2	32.1	36.0	40.2	44.1	46.2

Model Name	Stage	Rating kW	Rating HP	HEAD IN Mtrs.	16.5	16	14.5	14	13	12	11	10	8	7
6RP 32-01	1	1.50	2.00		16.5	16	14.5	14	13	12	11	10	8	7
6RP 32-02	2	3.00	4.00		33	31	29	28	26	25	22	19	16	14
6RP 32-03	3	4.00	5.50		50	47	43	42	40	37	33	29	24	21
6RP 32-04	4	5.50	7.50		66	63	58	55	53	49	45	39	31	28
6RP 32-05	5	7.50	10.00		82	79	72	69	66	62	56	48	39	35
6RP 32-06	6	9.30	12.50		99	94	87	83	79	74	67	58	47	42
6RP 32-07	7	9.30	12.50		116	110	101	97	92	86	78	67	55	49
6RP 32-08	8	11.00	15.00		132	126	116	111	106	99	89	77	63	56
6RP 32-09	9	13.00	17.50		148	141	130	125	119	111	100	87	71	63
6RP 32-10	10	13.00	17.50		165	157	145	139	132	123	111	96	79	70
6RP 32-11	11	15.00	20.00		182	173	159	152	145	136	123	106	86	77
6RP 32-12	12	18.50	25.00		198	189	174	166	159	148	134	116	94	84
6RP 32-13	13	18.50	25.00		214	204	188	180	172	160	145	125	102	90
6RP 32-14	14	18.50	25.00		231	220	202	194	185	172	156	135	110	97
6RP 32-15	15	22.00	30.00		248	236	217	208	198	185	167	145	118	104
6RP 32-16	16	22.00	30.00		264	251	231	222	211	197	178	154	126	111
6RP 32-17	17	22.00	30.00		280	267	246	236	225	209	189	164	134	118
6RP 32-18	18	26.00	35.00		297	283	260	249	238	222	201	174	141	125
6RP 32-19	19	26.00	35.00		314	298	275	263	251	234	212	183	149	132
6RP 32-20	20	26.00	35.00		330	314	289	277	264	246	223	193	157	139
6RP 32-21	21	30.00	40.00		346	330	304	291	277	259	234	202	165	146
6RP 32-22	22	30.00	40.00		363	346	318	305	291	271	245	212	173	153
6RP 32-23	23	30.00	40.00		380	361	333	319	304	283	256	222	181	160
6RP 32-24	24	37.00	50.00		396	377	347	333	317	296	267	231	189	167
6RP 32-25	25	37.00	50.00		412	393	362	346	330	308	278	241	196	174
6RP 32-26	26	37.00	50.00		429	408	376	360	343	320	290	251	204	181
6RP 32-27	27	37.00	50.00		446	424	390	374	357	333	301	260	212	188
6RP 32-28	28	37.00	50.00		462	440	405	388	370	345	312	270	220	195

**6RP 32, 60Hz**  
ISO 9906 Annexure A

**Dimensions & Weights**

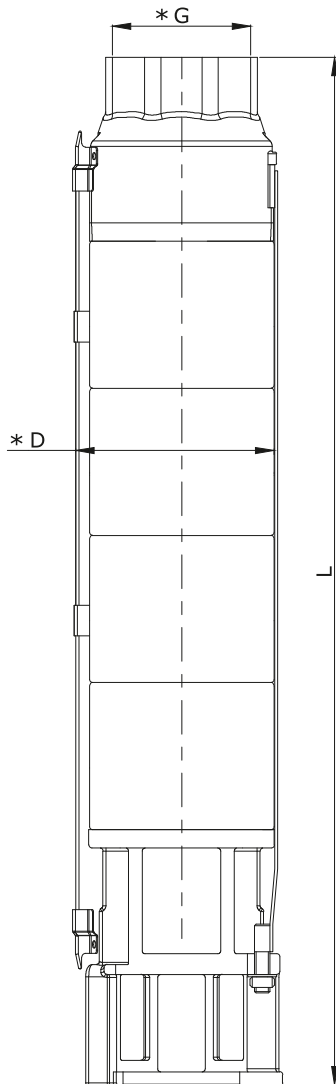

Model Name	Specification			
	*D (mm)	L (mm)	Pump Weight Kg.	Weight (Incl. pkg.) Kg.
6RP 32 - 01	142	369	9	14
6RP 32 - 02	142	465	11	16
6RP 32 - 03	142	561	13	18
6RP 32 - 04	142	657	15	20
6RP 32 - 05	142	753	11	16
6RP 32 - 06	142	849	19	24
6RP 32 - 07	142	947	21	26
6RP 32 - 08	142	1041	23	28
6RP 32 - 09	142	1137	25	30
6RP 32 - 10	142	1249	27	32
6RP 32 - 11	142	1345	29	34
6RP 32 - 12	142	1441	31	36
6RP 32 - 13	142	1537	33	38
6RP 32 - 14	142	1633	35	40
6RP 32 - 15	142	1729	37	47
6RP 32 - 16	142	1825	39	49
6RP 32 - 17	142	1921	41	51
6RP 32 - 18	142	2017	43	53
6RP 32 - 19	142	2113	45	55
6RP 32 - 20	142	2209	47	57
6RP 32 - 21	142	2305	49	59
6RP 32 - 22	142	2401	51	63
6RP 32 - 23	142	2497	53	65
6RP 32 - 24	142	2593	55	67
6RP 32 - 25	142	2689	57	69
6RP 32 - 26	142	2785	59	71
6RP 32 - 27	142	2881	61	73
6RP 32 - 28	142	2977	63	75

\*G : Available Outlet Size 2.5" NPT & 3.0" NPT

\*D : With Cable Guard

6RP 32 -01 to 6RP 32 -05 pumps are also available in 4" joining.

6RP 32 -29, 6RP 32 -31, 6RP 32 -33, 6RP 32 -36 & 6RP 32 -39 pumps are also available with & without mounted sleeve in 8" joining.

# 6RP 48 & 6RP 62 SERIES PUMP DESIGN

## Material Specification

No	PART NAME	MATERIAL
1	DISCHARGE CHAMBER HOUSING	STEEL CAST 304
2	VALVE	S.S.304
3	TOP & FIRST BEARING BUSH	N.B.R. + S.S.304
4	INTERMEDIATE CHAMBER TOP	S.S.304
5	COLLET NUT	S.S.304
6	IMPELLER	S.S.304
7	COLLET	S.S.304
8	BEARING BUSH	NBR
9	INTERMEDIATE CHAMBER STAGE	S.S.304
10	NECKRING	N.B.R. + NYLON
11	INTERMEDIATE CHAMBER 1st	S.S.304
12	SPACING WASHER	25% CFT
13	FIRST STAGE NUT	STEEL CAST 304
14	RETAINER	S.S.304
15	STRAINER	S.S.304
16	PUMP SHAFT (UP TO 09 STAGES)	S.S.431
	PUMP SHAFT (10 STAGE & ABOVE)	S.S.1.4362
17	NEMA COUPLING	S.S.304
18	CABLE GUARD	S.S.304
19	CLAMPING STRIP	S.S.304
20	HEX NUT	S.S. 316
21	SUCTION	STEEL CAST 304

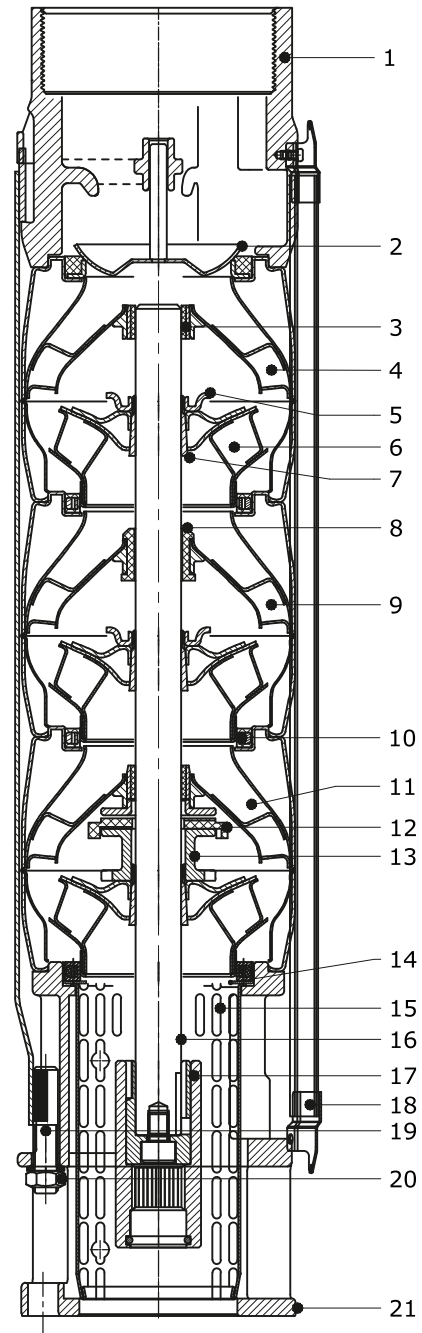

Note:  
 PUMPS UP TO 20 STAGE DISCHARGE CHAMBER COMES WITH S.S. FABRICATED AND FROM 21 STAGE & ONWARDS WITH STEEL CAST.

**6RP 48, 60Hz**  
ISO 9906 Annexure A

# PERFORMANCE CURVES

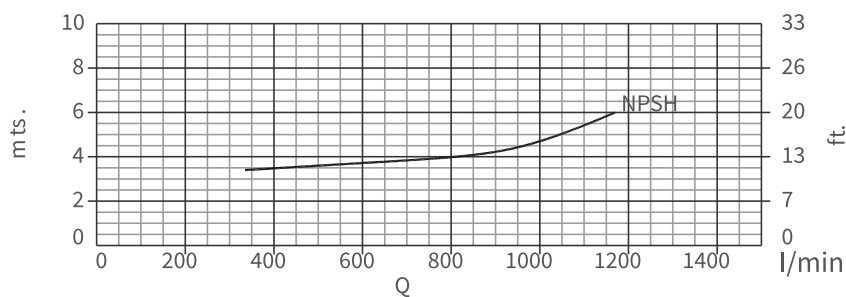
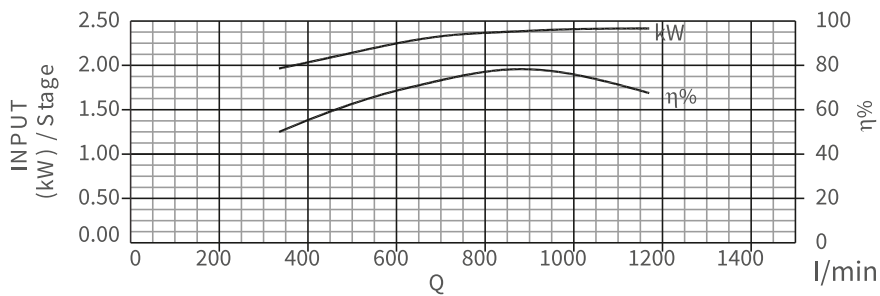
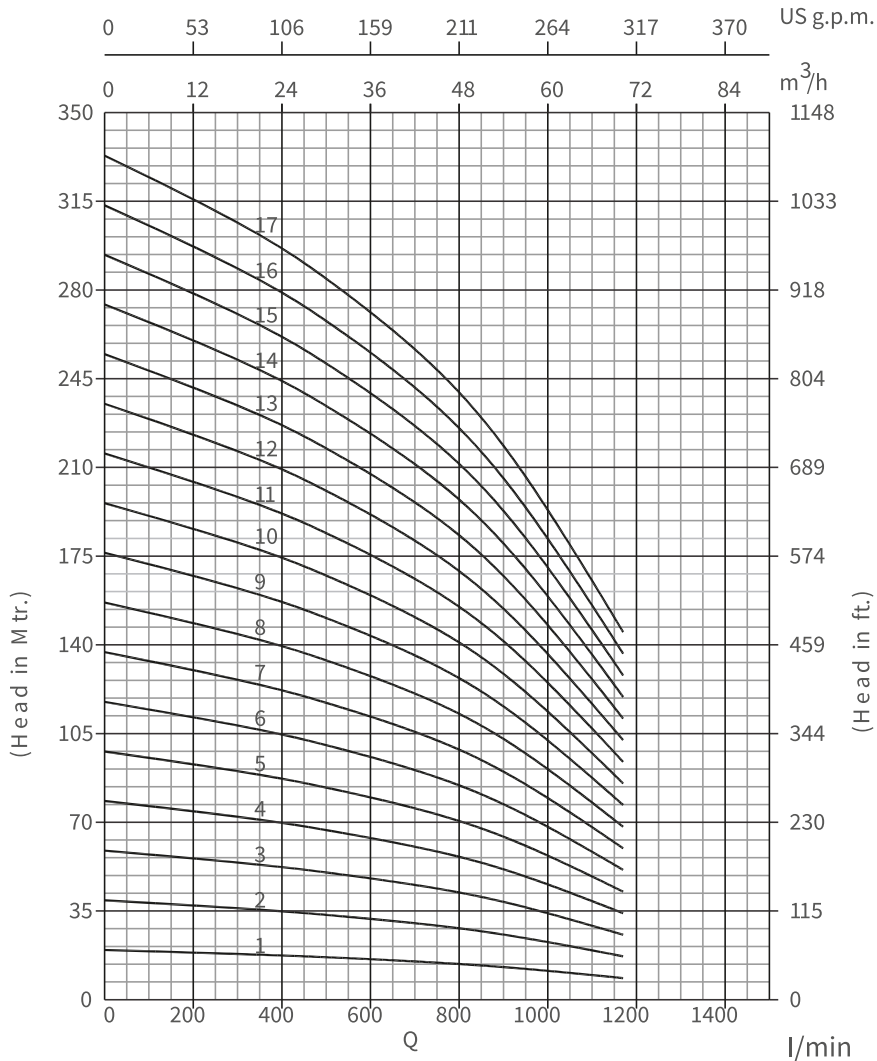

# PERFORMANCE CHART

MODEL NAME	STAGE	RATING		l/min m <sup>3</sup> /h	DISCHARGE						
		KW	HP		0	335	500	670	835	1000	1170
THREE PHASE					0	335	500	670	835	1000	1170
					0	20.1	30.0	40.2	50.1	60.0	70.2

MODEL NAME	STAGE	KW	HP	HEAD IN Mtrs.	0	335	500	670	835	1000	1170
6RP 48-01	1	3.00	4.00		20	18	17	15	14	11	9
6RP 48-02	2	5.50	7.50		39	36	34	31	28	23	17
6RP 48-03	3	7.50	10.00		59	54	50	46	41	34	26
6RP 48-04	4	9.30	12.50		78	72	67	62	55	46	34
6RP 48-05	5	13.00	17.50		98	90	84	77	69	57	43
6RP 48-06	6	15.00	20.00		118	108	101	92	83	69	51
6RP 48-07	7	18.50	25.00		137	126	117	108	97	80	60
6RP 48-08	8	18.50	25.00		157	144	134	123	111	92	68
6RP 48-09	9	22.00	30.00		176	161	151	139	124	103	77
6RP 48-10	10	22.00	30.00		196	179	168	154	138	115	85
6RP 48-11	11	26.00	35.00		215	197	184	170	152	126	94
6RP 48-12	12	30.00	40.00		235	215	201	185	166	138	102
6RP 48-13	13	30.00	40.00		255	233	218	200	180	149	111
6RP 48-14	14	37.00	50.00		274	251	235	216	193	161	119
6RP 48-15	15	37.00	50.00		294	269	251	231	207	172	128
6RP 48-16	16	37.00	50.00		313	287	268	247	221	184	136
6RP 48-17	17	37.00	50.00		333	305	285	262	235	195	145

**6RP 48, 60Hz**  
ISO 9906 Annexure A

## Dimensions & Weights

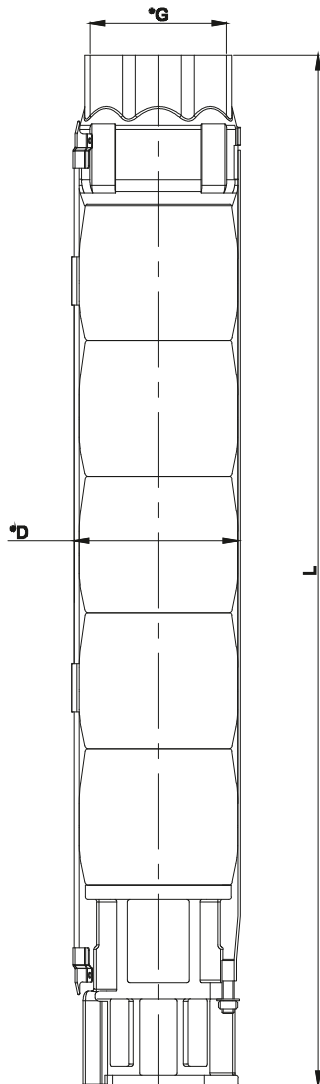

Model Name	Specification			
	*D (mm)	L (mm)	Pump Weight Kg.	Weight (Incl. pkg.) Kg.
6RP 48 - 01	147	400	10	13
6RP 48 - 02	147	513	12	15
6RP 48 - 03	147	628	14	17
6RP 48 - 04	147	741	16	19
6RP 48 - 05	147	854	18	22
6RP 48 - 06	147	967	20	24
6RP 48 - 07	147	1080	22	26
6RP 48 - 08	147	1193	24	28
6RP 48 - 09	147	1306	26	30
6RP 48 - 10	147	1436	28	33
6RP 48 - 11	147	1549	30	35
6RP 48 - 12	147	1662	32	39
6RP 48 - 13	147	1775	34	41
6RP 48 - 14	147	1888	36	43
6RP 48 - 15	147	2001	38	45
6RP 48 - 16	147	2114	40	48
6RP 48 - 17	147	2227	42	50

\*G : Available outlet size 3" NPT & 4" NPT

\*D : With cable Guard

6RP 48 -01 to 6RP 48 -03 pumps are also available in 4" joining.

6RP 48 -18, 6RP 48 -19, 6RP 48 -20, 6RP 48 -22 & 6RP 48 -24 pumps are also available with & without mounted sleeve in 8" joining.

# PERFORMANCE CURVES

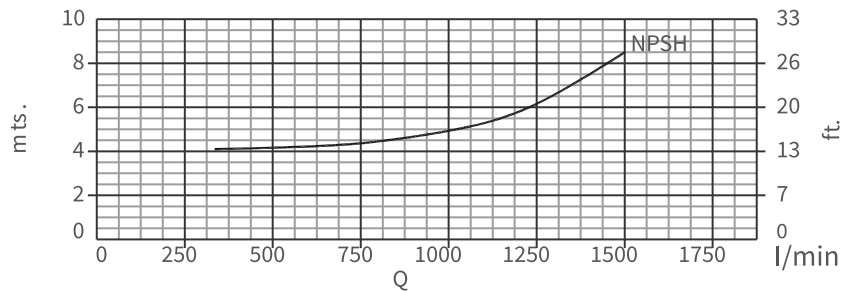
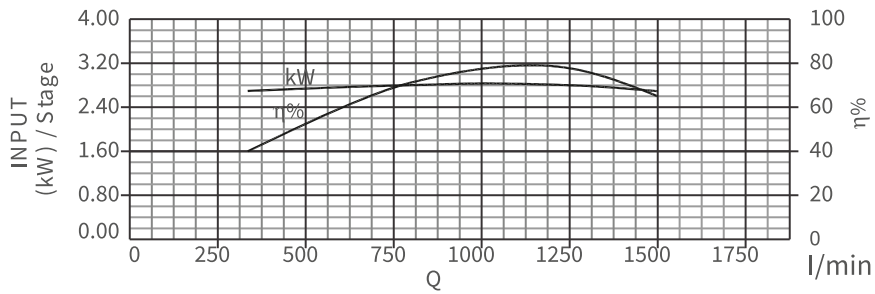
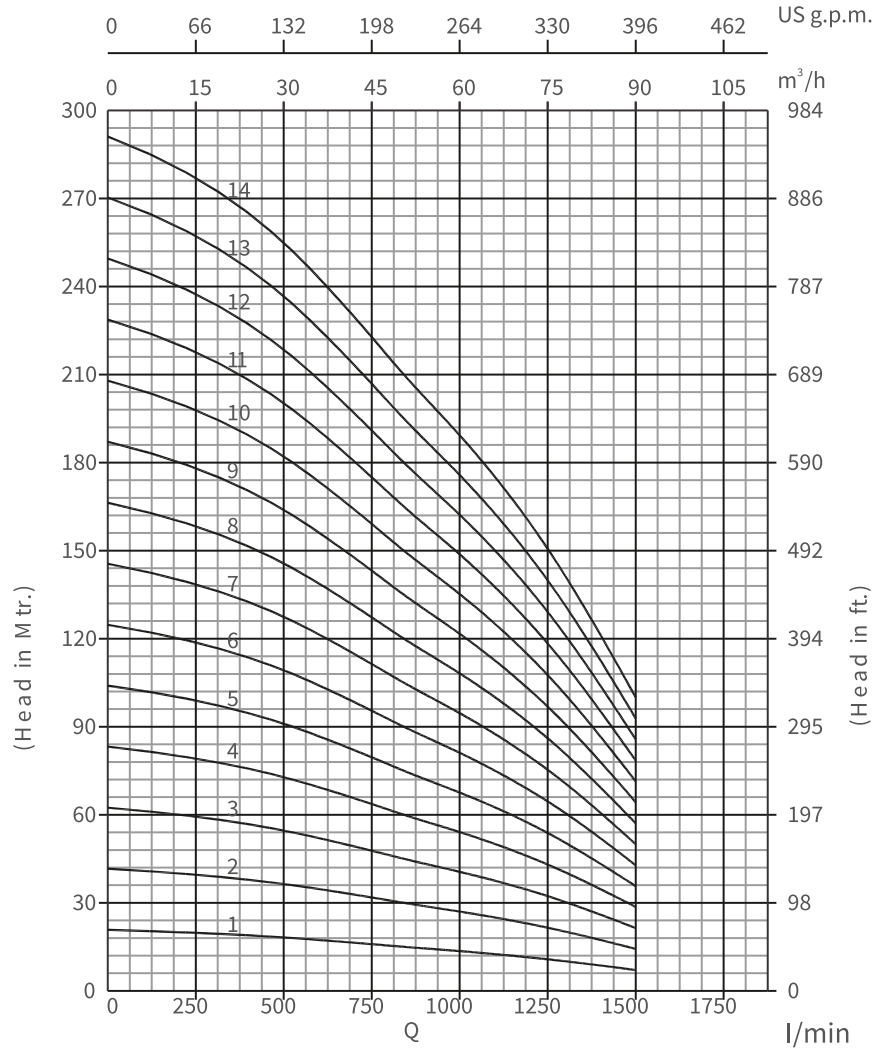

**6RP 62, 60Hz**  
ISO 9906 Annexure A

## PERFORMANCE CHART

MODEL NAME	STAGE	RATING		DISCHARGE	DISCHARGE							
		kW	HP		l/min	0	335	670	835	1000	1170	1335
THREE PHASE				m <sup>3</sup> /h	0	20.1	40.2	50.1	60.0	70.2	80.1	90.0

MODEL NAME	STAGE	kW	HP	HEAD IN Mtrs.	21	20	17	15	14	12	10	7
6RP 62-01	1	4.00	5.50		21	20	17	15	14	12	10	7
6RP 62-02	2	5.50	7.50		42	39	34	30	27	24	19	14
6RP 62-03	3	9.30	12.50		62	59	50	45	41	35	29	21
6RP 62-04	4	11.00	15.00		83	79	67	60	54	47	39	29
6RP 62-05	5	13.00	17.50		104	99	84	75	68	59	49	36
6RP 62-06	6	18.50	25.00		125	118	101	90	81	71	58	43
6RP 62-07	7	18.50	25.00		146	138	118	105	95	83	68	50
6RP 62-08	8	22.00	30.00		166	158	134	120	109	94	78	57
6RP 62-09	9	26.00	35.00		187	177	151	135	122	106	87	64
6RP 62-10	10	26.00	35.00		208	197	168	150	136	118	97	71
6RP 62-11	11	30.00	40.00		229	217	185	165	149	130	107	79
6RP 62-12	12	37.00	50.00		249	237	201	180	163	141	117	86
6RP 62-13	13	37.00	50.00		270	256	218	195	176	153	126	93
6RP 62-14	14	37.00	50.00		291	276	235	210	190	165	136	100

## Dimensions & Weights

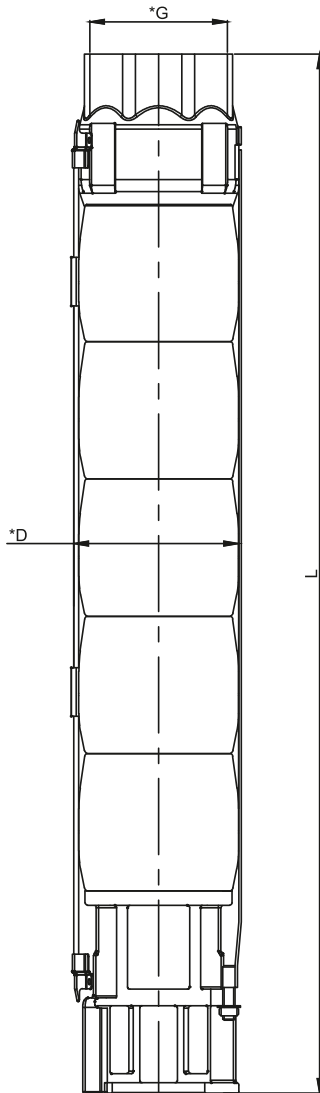

Model Name	Specification			
	*D (mm)	L (mm)	Pump Weight Kg.	Weight (Incl. pkg.) Kg.
6RP 62 - 01	147	400	10	13
6RP 62 - 02	147	513	12	15
6RP 62 - 03	147	628	14	17
6RP 62 - 04	147	741	16	19
6RP 62 - 05	147	854	18	22
6RP 62 - 06	147	967	20	24
6RP 62 - 07	147	1080	22	26
6RP 62 - 08	147	1193	24	28
6RP 62 - 09	147	1306	26	30
6RP 62 - 10	147	1436	28	33
6RP 62 - 11	147	1549	30	35
6RP 62 - 12	147	1662	32	39
6RP 62 - 13	147	1775	34	41
6RP 62 - 14	147	1888	36	43

\*G : Available outlet size 3" NPT & 4" NPT

\*D : With cable Guard

6RP 62 -01 to 6RP 62 -03 pumps are also available in 4" joining.

6RP 62 -15 to 6RP 62 -21 pumps are also available with & without mounted sleeve in 8" joining.